



Owner's Manual

Contents

USING THE UNIT SAFELY	2	Convenient Functions	9
IMPORTANT NOTES	4	Calling Up Scenes/Echos	9
Main Features	5	Saving Scenes/Echos	9
Panel Descriptions	6	Editing the KSP-100's Basic Parameters	9
Front Panel	6	Compensating for the Room Acoustics (Room Acoustic Auto Control)	10
Rear Panel	7	Automatically Switching the Input Signal	11
Basic Operation	8	Changing How Switching Occurs When High-priority Signals are Input	11
Turning the Power On	8	Preventing Acoustic Feedback (Static Anti-Feedback)	12
Turning the Power Off	8	Locking Parameters to Prevent Changes (Panel Lock)	12
Top Screen	8	Releasing Panel Lock	12
Changing the Page of the Top Screen	8	Returning the KSP-100's Settings to Default Factory Settings (Factory Reset)	12
Moving the Cursor	8	Changing the Settings	13
Displaying the Advanced Settings Screen	8	Setting the MIC Parameters	13
Changing a Value	8	Setting the MUSIC Parameters	15
		Setting the OUTPUT Parameters	15
		Setting the SYSTEM Parameters	16
		Appendix	19
		Block Diagram	19
		Specifications	20

Before using this unit, carefully read the sections entitled: "USING THE UNIT SAFELY" (p.2) and "IMPORTANT NOTES" (p.4). These sections provide important information concerning the proper operation of the unit. Additionally, in order to feel assured that you have gained a good grasp of every feature provided by your new unit, read Owner's Manual in its entirety. This manual should be saved and kept on hand as a convenient reference.

Copyright © 2013 BMB International Corp.



All rights reserved. No part of this publication may be reproduced in any form without the written permission of BMB International Corp.









USING THE UNIT SAFELY

INSTRUCTIONS FOR THE PREVENTION OF FIRE, ELECTRIC SHOCK, OR INJURY TO PERSONS

About WARNING and CAUTION Notices

 WARNING	Used for instructions intended to alert the user to the risk of death or severe injury should the unit be used improperly.
 CAUTION	Used for instructions intended to alert the user to the risk of injury or material damage should the unit be used improperly. * Material damage refers to damage or other adverse effects caused with respect to the home and all its furnishings, as well to domestic animals or pets.

About the Symbols

	The  symbol alerts the user to important instructions or warnings. The specific meaning of the symbol is determined by the design contained within the triangle. In the case of the symbol at left, it is used for general cautions, warnings, or alerts to danger.
	The  symbol alerts the user to items that must never be carried out (are forbidden). The specific thing that must not be done is indicated by the design contained within the circle. In the case of the symbol at left, it means that the unit must never be disassembled.
	The  symbol alerts the user to things that must be carried out. The specific thing that must be done is indicated by the design contained within the circle. In the case of the symbol at left, it means that the power-cord plug must be unplugged from the outlet.

ALWAYS OBSERVE THE FOLLOWING

WARNING

Do not disassemble or modify by yourself
Do not open (or modify in any way) the unit or its AC adaptor.



Do not repair or replace parts by yourself
Do not attempt to repair the unit, or replace parts within it (except when this manual provides specific instructions directing you to do so). Refer all servicing to your retailer.



Do not use or store in the following types of locations

- Subject to temperature extremes (e.g., direct sunlight in an enclosed vehicle, near a heating duct, on top of heat-generating equipment); or are
- Damp (e.g., baths, washrooms, on wet floors); or are
- Exposed to steam or smoke; or are
- Subject to salt exposure; or are
- Humid; or are
- Exposed to rain; or are
- Dusty or sandy; or are
- Subject to high levels of vibration and shakiness.



Do not place in an unstable location

Make sure you always have the unit placed so it is level and sure to remain stable. Never place it on stands that could wobble, or on inclined surfaces.



WARNING

Use only the supplied AC adaptor and the correct voltage

Be sure to use only the AC adaptor supplied with the unit. Also, make sure the line voltage at the installation matches the input voltage specified on the AC adaptor's body. Other AC adaptors may use a different polarity, or be designed for a different voltage, so their use could result in damage, malfunction, or electric shock.



Use only the supplied power cord

Use only the attached power-supply cord. Also, the supplied power cord must not be used with any other device.



Do not bend the power cord or place heavy objects on it

Do not excessively twist or bend the power cord, nor place heavy objects on it. Doing so can damage the cord, producing severed elements and short circuits. Damaged cords are fire and shock hazards!



Avoid extended use at high volume

This unit in combination with an amplifier and headphones or speakers may be capable of producing sound levels that could cause permanent hearing loss. Do not operate for a long period of time at a high volume level, or at a level that is uncomfortable. If you experience any hearing loss or ringing in the ears, you should immediately stop using the unit, and consult an audiologist.



WARNING

Don't allow foreign objects or liquids to enter unit; never place containers with liquid on unit

Do not place containers containing liquid (e.g., flower vases) on this product. Never allow foreign objects (e.g., flammable objects, coins, wires) or liquids (e.g., water or juice) to enter this product. Doing so may cause short circuits, faulty operation, or other malfunctions.



Turn off the unit if an abnormality or malfunction occurs

Immediately turn the unit off, remove the AC adaptor from the outlet, and request servicing by your retailer:



- The AC adaptor, the power-supply cord, or the plug has been damaged; or
- If smoke or unusual odor occurs; or
- Objects have fallen into, or liquid has been spilled onto the unit; or
- The unit has been exposed to rain (or otherwise has become wet); or
- The unit does not appear to operate normally or exhibits a marked change in performance.

Adults must provide supervision in places where children are present

When using the unit in locations where children are present, be careful so no mishandling of the unit can take place. An adult should always be on hand to provide supervision and guidance.



Do not drop or subject to strong impact

Protect the unit from strong impact. (Do not drop it!)



! WARNING

Do not share an outlet with an unreasonable number of other devices

Do not force the unit's power-supply cord to share an outlet with an unreasonable number of other devices. Be especially careful when using extension cords—the total power used by all devices you have connected to the extension cord's outlet must never exceed the power rating (watts/amperes) for the extension cord. Excessive loads can cause the insulation on the cord to heat up and eventually melt through.



Do not use overseas

Before using the unit in a foreign country, consult with your retailer.



! CAUTION

Place in a well ventilated location

The unit and the AC adaptor should be located so their location or position does not interfere with their proper ventilation.



Grasp the plug when connecting or disconnecting the AC adaptor

Always grasp only the plug on the AC adaptor cord when plugging into, or unplugging from, an outlet or this unit.



Periodically clean the AC adaptor's plug

At regular intervals, you should unplug the AC adaptor and clean it by using a dry cloth to wipe all dust and other accumulations away from its prongs. Also, disconnect the power plug from the power outlet whenever the unit is to remain unused for an extended period of time. Any accumulation of dust between the power plug and the power outlet can result in poor insulation and lead to fire.



Manage cables for safety

Try to prevent cords and cables from becoming entangled. Also, all cords and cables should be placed so they are out of the reach of children.



Avoid climbing on top of the unit, or placing heavy objects on it

Never climb on top of, nor place heavy objects on the unit.



! CAUTION

Do not connect or disconnect the AC adaptor with wet hands

Never handle the AC adaptor or its plugs with wet hands when plugging into, or unplugging from, an outlet or this unit.



Disconnect everything before moving the unit

Before moving the unit, disconnect the AC adaptor and all cords coming from external devices.



Unplug the AC adaptor from the outlet before cleaning

Before cleaning the unit, turn it off and unplug the AC adaptor from the outlet (p. 7).



If there's a threat of lightning, don't touch the AC adaptor

Whenever you suspect the possibility of lightning in your area, do not touch the AC adaptor or this unit.



Keep small items out of the reach of children

To prevent accidental ingestion of the parts listed below, always keep them out of the reach of small children.



- Removable Parts
- Screws

Handle the ground terminal carefully

If you remove the screw from the ground terminal, be sure to replace it; don't leave it lying around where it could accidentally be swallowed by small children. When refastening the screw, make that it is firmly fastened, so it won't come loose.



IMPORTANT NOTES

Power Supply

- Do not connect this unit to same electrical outlet that is being used by an electrical appliance that is controlled by an inverter or a motor (such as a refrigerator, washing machine, microwave oven, or air conditioner). Depending on the way in which the electrical appliance is used, power supply noise may cause this unit to malfunction or may produce audible noise. If it is not practical to use a separate electrical outlet, connect a power supply noise filter between this unit and the electrical outlet.
- The AC adaptor will begin to generate heat after long hours of consecutive use. This is normal, and is not a cause for concern.
- To prevent malfunction and equipment failure, always make sure to turn off the power on all your equipment before you make any connections.

Placement

- Using the unit near power amplifiers (or other equipment containing large power transformers) may induce hum. To alleviate the problem, change the orientation of this unit; or move it farther away from the source of interference.
- This device may interfere with radio and television reception. Do not use this device in the vicinity of such receivers.
- Noise may be produced if wireless communications devices, such as cell phones, are operated in the vicinity of this unit. Such noise could occur when receiving or initiating a call, or while conversing. Should you experience such problems, you should relocate such wireless devices so they are at a greater distance from this unit, or switch them off.
- Do not expose the unit to direct sunlight, place it near devices that radiate heat, leave it inside an enclosed vehicle, or otherwise subject it to temperature extremes. Excessive heat can deform or discolor the unit.
- When moved from one location to another where the temperature and/or humidity is very different, water droplets (condensation) may form inside the unit. Damage or malfunction may result if you attempt to use the unit in this condition. Therefore, before using the unit, you must allow it to stand for several hours, until the condensation has completely evaporated.
- Depending on the material and temperature of the surface on which you place the unit, its rubber feet may discolor or mar the surface. You can place a piece of felt or cloth under the rubber feet to prevent this from happening. If you do so, please make sure that the unit will not slip or move accidentally.
- Do not put anything that contains water on this unit. Also, avoid the use of insecticides, perfumes, alcohol, nail polish, spray cans, etc., near the unit. Swiftly wipe away any liquid that spills on the unit using a dry, soft cloth.

Maintenance

- For everyday cleaning wipe the unit with a soft, dry cloth or one that has been slightly dampened with water. To remove stubborn dirt, use a cloth impregnated with a mild, non-abrasive detergent. Afterwards, be sure to wipe the unit thoroughly with a soft, dry cloth.
- Never use benzine, thinners, alcohol or solvents of any kind, to avoid the possibility of discoloration and/or deformation.

Additional Precautions

- Please be aware that the contents of memory can be irretrievably lost as a result of a malfunction, or the improper operation of the unit.
- Unfortunately, it may be impossible to restore the contents of data that was stored in the unit's memory once it has been lost. BMB International Corp. assumes no liability concerning such loss of data.
- Use a reasonable amount of care when using the unit's buttons, sliders, or other controls; and when using its jacks and connectors. Rough handling can lead to malfunctions.
- Never strike or apply strong pressure to the display.
- When disconnecting all cables, grasp the connector itself—never pull on the cable. This way you will avoid causing shorts, or damage to the cable's internal elements.
- When you need to transport the unit, package it in the box (including padding) that it came in, if possible. Otherwise, you will need to use equivalent packaging materials.
- Some connection cables contain resistors. Do not use cables that incorporate resistors for connecting to this unit. The use of such cables can cause the sound level to be extremely low, or impossible to hear. For information on cable specifications, contact the manufacturer of the cable.

- Depending on the circumstances of a particular setup, you may experience a discomforting sensation, or perceive that the surface feels gritty to the touch when you touch this device, microphones connected to it, or the metal portions of other objects. This is due to an infinitesimal electrical charge, which is absolutely harmless. However, if you are concerned about this, connect the ground terminal (see figure) with an external ground. When the unit is grounded, a slight hum may occur, depending on the particulars of your installation.



Unsuitable places for connection

- Water pipes (may result in shock or electrocution)
- Gas pipes (may result in fire or explosion)
- Telephone-line ground or lightning rod (may be dangerous in the event of lightning)

Copyrights / Licenses / Trademarks

- It is forbidden by law to make an audio recording, video recording, copy or revision of a third party's copyrighted work (musical work, video work, broadcast, live performance, or other work), whether in whole or in part, and distribute, sell, lease, perform, or broadcast it without the permission of the copyright owner.
- Do not use this product for purposes that could infringe on a copyright held by a third party. We assume no responsibility whatsoever with regard to any infringements of third-party copyrights arising through your use of this product.
- MMP (Moore Microprocessor Portfolio) refers to a patent portfolio concerned with microprocessor architecture, which was developed by Technology Properties Limited (TPL). Roland has licensed this technology from the TPL Group.
- This product contains eCROS integrated software platform of eSOL Co.,Ltd. eCROS is a trademark of eSOL Co., Ltd. in Japan.
- Roland and V-Remastering are either registered trademarks or trademarks of Roland Corporation in the United States and/or other countries.
- Company names and product names appearing in this document are registered trademarks or trademarks of their respective owners.

Main Features

HANAMICHI Effect (p. 15)

This effect uses Roland's V-Remastering technology to shift any of the accompaniment music that is at the center of the soundstage to the left or right. This makes it easier to hear the vocals, and makes it easier for the singer to perform.

* HANAMICHI and 花道 are trademarks of Roland Corporation.

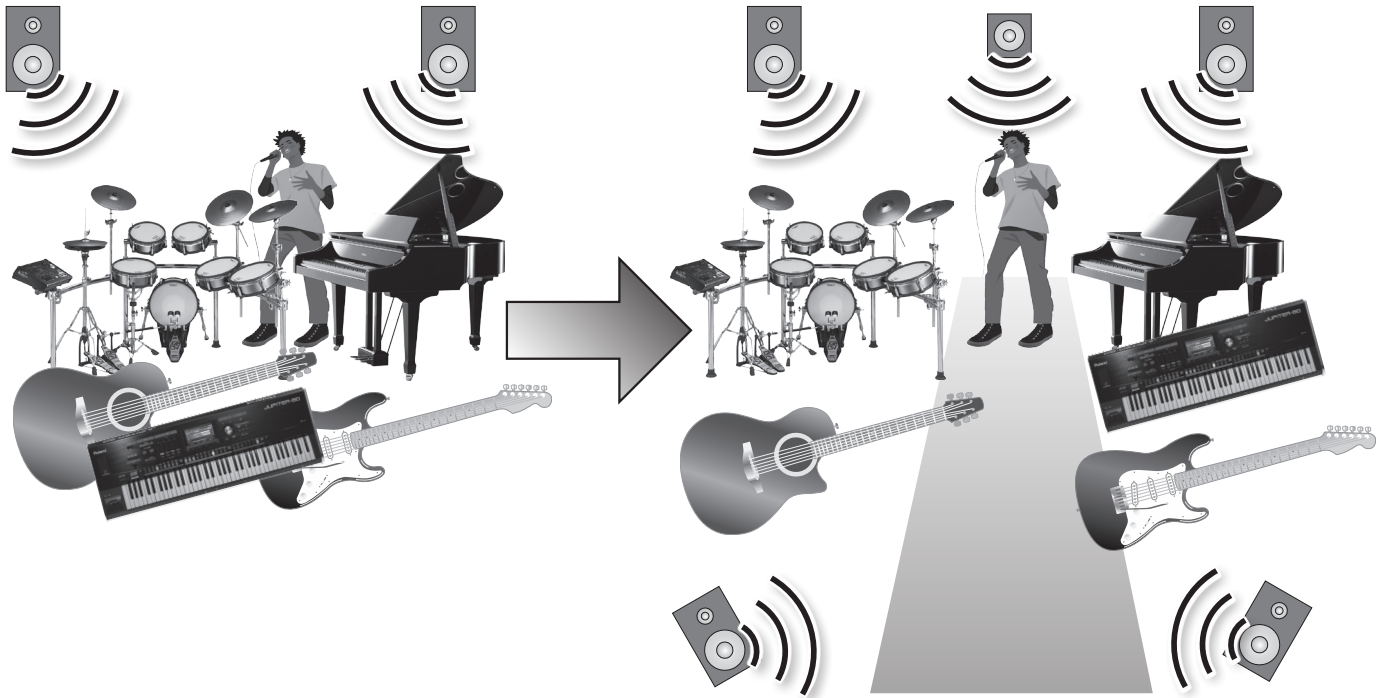

5.1-Channel Audio Output

Produces powerful and multidimensional sound.

Room Acoustic Auto Control Function (p. 10)

Adjusts the output signals (tone) on each channel automatically according to the room acoustics.

15-Band Graphic Equalizer and Parametric Equalizer (p. 13)

Equipped with an equalizer for sound output from each channel. The equalizer can be used as a graphic equalizer or parametric equalizer, allowing you to adjust the tone quality to your preferred sound.

High-Quality Reverb and Echo (p. 13)

Equipped with effects filled with know-how gained in the karaoke market.

Provides immersive ambience and lustrous vocal echo.

Anti-Feedback Function (p. 12, p. 16)

Reduces unpleasant acoustic feedback that may be produced depending on the position and volume of microphones and speakers.

Vocal Compressor That Reduces Fluctuations in the Volume (p. 13)

Standard effect for vocals that reduces fluctuations in microphone volume.

Automatic Switching Function for Video and Audio (p. 11)

Detects the presence of video and audio signals from karaoke players and BGV players, and switches the video and audio automatically.

External Control Function

Equipped with three types of external control functions: USB, RS-232C, and infrared. This allows you to set the parameters from external devices and call or save scenes or echos (p. 9).

Panel Descriptions

Front Panel

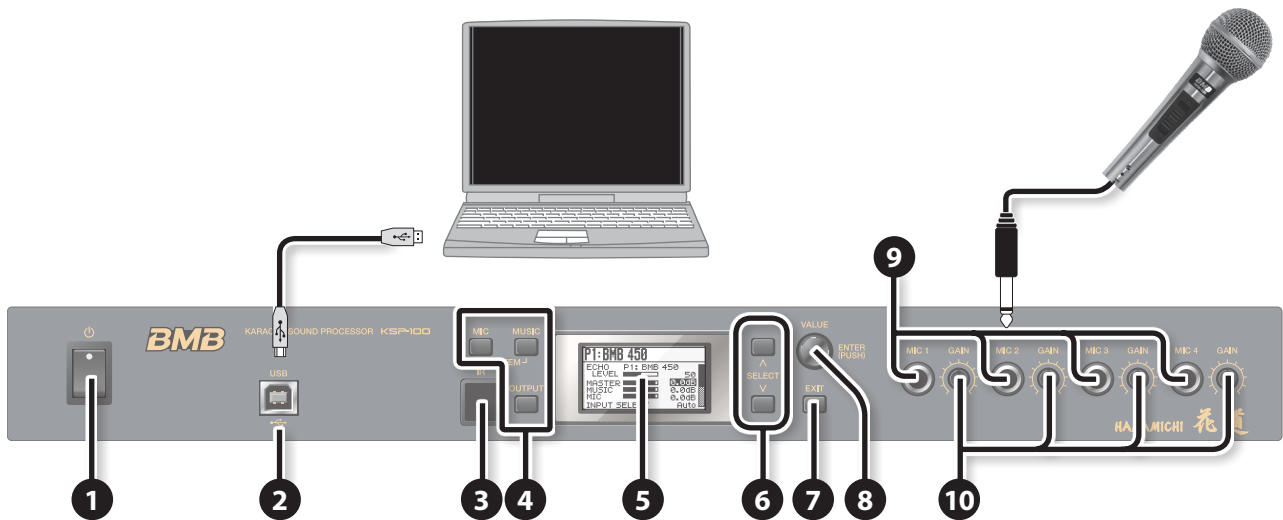

1	[] (POWER) switch	This switches the power on and off.
2	USB port	Port for connecting maintenance PCs.
3	IR (Infrared Receiver)	Receives remote control (sold separately) operations.
4	[MIC] button	Displays the "MIC" screen.
	[MUSIC] button	Displays the "MUSIC" screen.
	[OUTPUT] button	Displays the "OUTPUT" screen.
	[MIC] + [MUSIC] (SYSTEM) buttons (While holding down the [MIC] button, press the [MUSIC] button.)	Displays the "SYSTEM" screen.
5	Display	Displays various information depending on the operation.
6	SELECT [] [] buttons	Moves the cursor position.
7	[EXIT] button	Returns you to the previous screen. On some screens, this stops the execution of a function. In the top screen, you can press the [EXIT] button to access the Key Control screen. Turn the [VALUE] knob to change the pitch of the music. Press the [EXIT] button once again to close the screen.
8	[VALUE] knob ([ENTER] button)	Turn the knob to switch the scene (p. 9) or change the parameter value. Press the knob to confirm the new value or execute an operation. In the top screen, you can press the [ENTER] button to mute all sound. Press it once again to cancel muting.
9	MIC 1-MIC 4 jacks	Connects the microphones.
10	[GAIN] knobs	Adjust the input sensitivity for MICs 1-4.

To prevent malfunction and equipment failure, always turn down the volume, and turn off all the units before making any connections.

Rear Panel

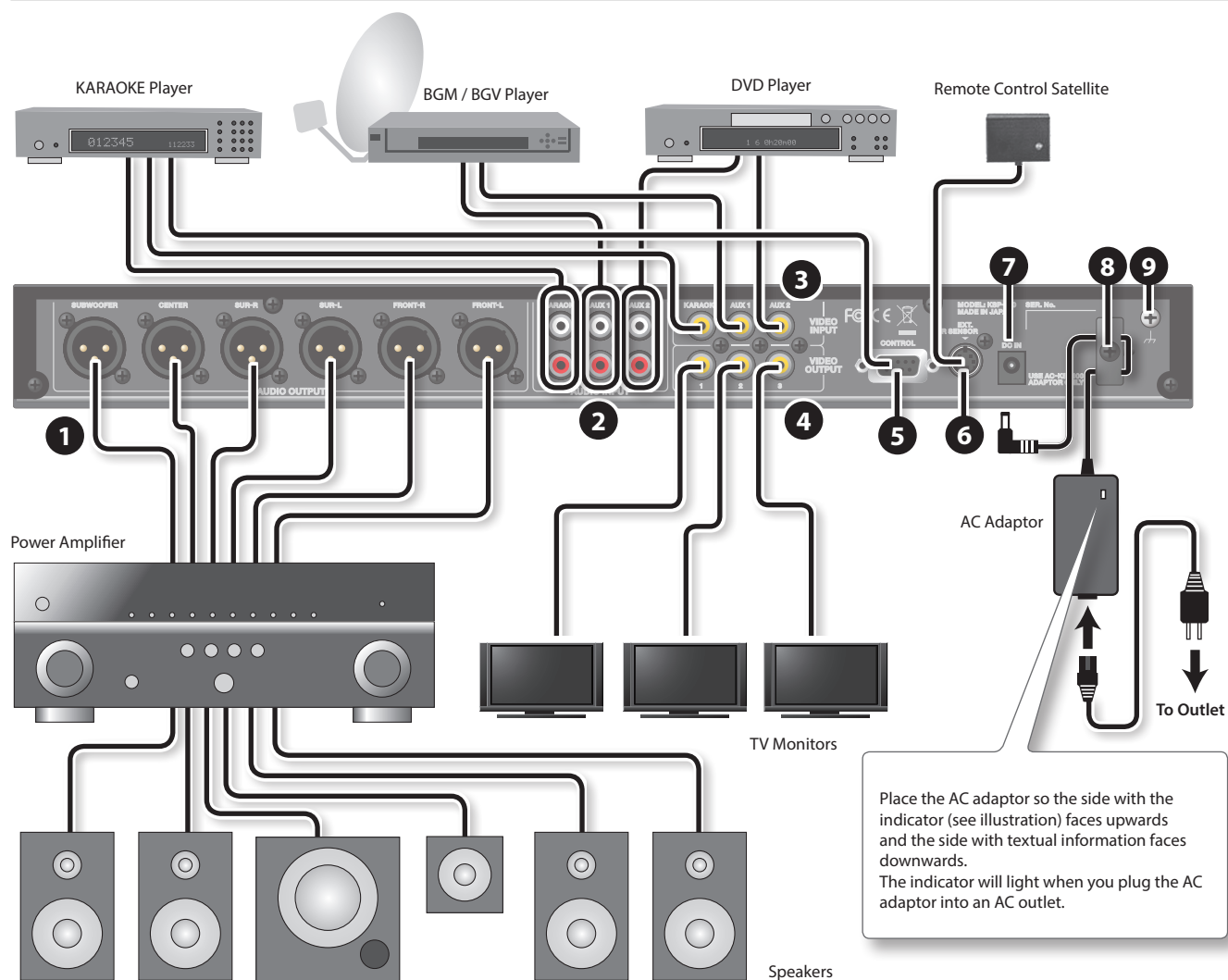

Place the AC adaptor so the side with the indicator (see illustration) faces upwards and the side with textual information faces downwards. The indicator will light when you plug the AC adaptor into an AC outlet.

1	AUDIO OUTPUT (FRONT-L, FRONT-R, SUR-L, SUR-R, CENTER, SUBWOOFER) connectors	Accept connection of a commercially available power amplifier. This provides 5.1-channel audio output. * This instrument is equipped with balanced (XLR) type connectors. Wiring diagram for these jacks are shown at right. Make connections after first checking the wiring diagrams of other equipment you intend to connect.	
2	AUDIO INPUT (KARAOKE, AUX 1, AUX 2) jacks	Accept connection of the audio output plugs from external devices (such as a KARAOKE player or DVD player). By setting the AUX1 Input Type or AUX2 Input Type parameter (p. 17) to "MIC," you can use the AUX 1 or AUX 2 jack as a mic input.	
3	VIDEO INPUT (KARAOKE, AUX 1, AUX 2) jacks	Accept connection of the video output plugs from external devices (such as a KARAOKE player or DVD player).	
4	VIDEO OUTPUT (1-3) jacks	Accept connection of TV monitors. Video selected in "INPUT SELECT" (p. 9) appears on the monitor. The same video is output from these three jacks.	
5	CONTROL connector	Accept connection of the KARAOKE player. This allows you to control KSP-100 from the KARAOKE player.	
6	EXT. R SENSOR connector	Accept connection of the Remote Control Satellite. This is used when the KSP-100's IR (Infrared Receiver) cannot be used (for example when it is too far away).	
7	DC IN jack	Connect the supplied AC adaptor here.	
8	Cord hook	Hook the AC adaptor's power cord here. * To prevent the inadvertent disruption of power to your unit (should the plug be pulled out accidentally), and to avoid applying undue stress to the DC IN jack, anchor the power cord using the cord hook, as shown in the illustration.	
9	Ground terminal	Connect this to ground (p. 4).	

To prevent malfunction and equipment failure, always turn down the volume, and turn off all the units before making any connections.

Basic Operation

This section introduces the basic operations for using the KSP-100.

Turning the Power On

Once everything is properly connected (p. 6, p. 7), be sure to follow the procedure below to turn on their power. If you turn on equipment in the wrong order, you risk causing malfunction or equipment failure.

MEMO

- This unit is equipped with a protection circuit. A brief interval (a few seconds) after turning the unit on is required before it will operate normally.
- Before turning the unit on/off, always be sure to turn the volume down. Even with the volume turned down, you might hear some sound when switching the unit on/off. However, this is normal and does not indicate a malfunction.

1. Turn on the KSP-100's (⏻) (POWER) switch.
2. Turn on the power of all peripheral devices except the power amplifier.
3. Turn the volume of the power amplifier all the way down.
4. Turn on the power amplifier.
5. Adjust the volume of the power amplifier.
Make sure the audio input to KSP-100 is coming out of the speakers. Also, make sure the video is displayed on the TV monitor.

Turning the Power Off

1. Turn the volume of the power amplifier all the way down.
2. Turn off the power amplifier.
3. Turn off the KSP-100's (⏻) (POWER) switch and turn off the power of peripheral devices.

Top Screen

This screen is the basic screen that appears when you turn on the power.

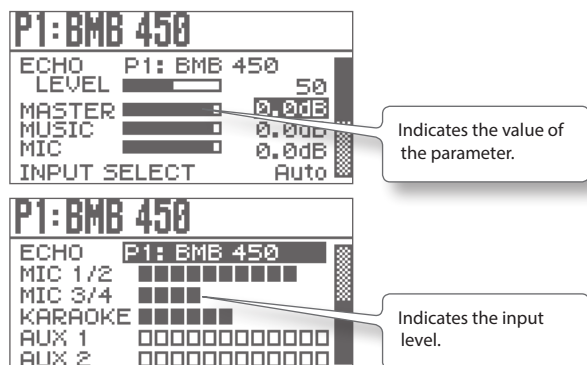

MEMO

- The explanations in this manual include illustrations that depict what should typically be shown by the display.
Note, however, that your unit may incorporate a newer, enhanced version of the system, so what you actually see in the display may not always match what appears in the manual.
- The figure above is the screen displayed when the "Top Screen Design" parameter is set to "Type 1." A different screen is displayed if the parameter is not set to "Type 1."

Changing the Page of the Top Screen

In the Top screen, press the SELECT [▲] [▼] buttons a number of times to display other page of top screen.

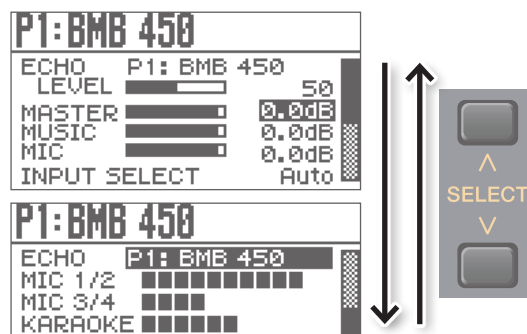

Moving the Cursor

There are multiple parameters (settings) and selections on the screen.

Press the SELECT [▲] [▼] buttons to move the cursor.

The parameter value selected with the cursor will be highlighted.

Displaying the Advanced Settings Screen

Move the cursor to an item that begins with ▼ and press the [ENTER] button; the advanced setting screen will appear.

However, the advanced setting screen will not appear if the setting is "Off."



Press the [EXIT] button to go back to the previous screen.

Changing a Value

To change a parameter setting, move the cursor to the applicable parameter value, then turn the [VALUE] knob to change the value. The value increases when the [VALUE] knob is turned clockwise and decreases when it is turned counterclockwise.

Conventions for describing procedures

In this document, an operation such as pressing the [MUSIC] button, selecting "Compressor," and then pressing the [ENTER] button is described as shown below.

Example:

1. Follow this sequence of steps: [MUSIC] button → "Compressor" → [ENTER] button.

In this document, an operation such as pressing the [MIC] button and [MUSIC] button at the same time is described as shown below.

Example:

1. Press [MIC] + [MUSIC] (SYSTEM) buttons.

Convenient Functions

Calling Up Scenes/Echos

You can save the echo parameters collectively as "Echo." The HANAMICHI parameters and other settings can be collectively stored as a "scene" and recalled whenever you want. There are nine "Preset Scene" types, which can only be called up, and nine "User Scene" types for saving parameters that you have set. The same applies to the echo type.

1. In the top screen, move the cursor to the scene name or echo name.
2. Turn the [VALUE] knob.
The scene or echo is called up.

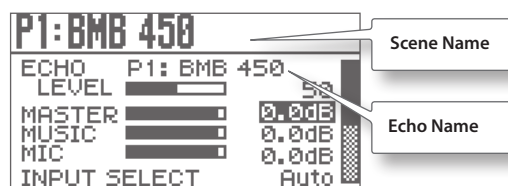

MEMO

- You can call up that scene or echo number automatically when the KSP-100 is turned on. For more information, see "Startup Scene" (p. 17) or "Startup Echo" (p. 17).
- The figure above is the screen displayed when the "Top Screen Design" (p. 17) parameter is set to "Type 1." A different screen is displayed if the parameter is not set to "Type 1."

Saving Scenes/Echos

You can save scene parameters and echo parameters. The following explanation describes the procedure to use when you're saving scene parameters.

Use the SYSTEM parameter "Echo Save" to save echo parameters.

1. Follow this sequence of steps: [MIC] + [MUSIC] (SYSTEM) buttons → "Scene Save" → [ENTER] button.

The "Scene Save" screen appears.

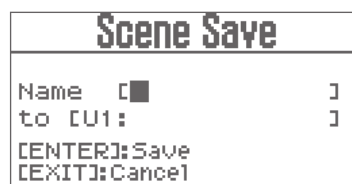

2. Enter the name of the scene for "Name."
Press the SELECT [▲] [▼] buttons to move the cursor, and use the [VALUE] knob to select characters.
3. Move the cursor to the "to" field, and select the scene number in which you want to save the settings.
Select the Scene Number (U1-U9).
4. Press the [ENTER] button.
The message "Are you sure?" appears.
5. Press the [ENTER] button to save the settings.
Press the [EXIT] to cancel.

NOTE

When the scene or echo is saved, it overwrites the data with new information.

The values for the SYSTEM parameters will not be saved. The values for the SYSTEM parameters are saved automatically when you access the top screen.

If the "*" symbol appears

When you edit one of the KSP-100's parameters, "*" symbols may appear.



If you select another scene or echo, or turn off the power while the "*" symbol is shown, the changes you made will be lost.

If you want to keep the changes you made, save the scene or echo as described in "Saving Scenes/Echos" (p. 9). (The "*" symbol will disappear when you save the scene or echo.)

Editing the KSP-100's Basic Parameters

The top screen shows the following basic parameters, allowing you to quickly edit their settings.

Parameter	Value	Explanation
ECHO LEVEL	0-100	MIC echo level
MASTER	Mute, -64.0dB-+6.0dB	Output master level (*)
MUSIC	Mute, -64.0dB-+6.0dB	Overall level for the KARAOKE, AUX 1, and AUX 2 jacks (*)
MIC	Mute, -64.0dB-+6.0dB	MIC total input level (*)
INPUT SELECT	Auto, KARAOKE, AUX1, AUX2	Selects the INPUT jack for which input is enabled. For more information, see "Automatically Switching the Input Signal" (p. 11).

MEMO

(*) You can use "Maximum Level" (p. 17) to specify the upper limit for these settings. This can prevent excessive playback volume that might occur if the MASTER, MUSIC, or MIC parameters are changed inadvertently.

Compensating for the Room Acoustics (Room Acoustic Auto Control)

This function measures the room acoustics and makes adjustments so appropriate audio for the room comes out of each speaker. The "Output EQ > FRONT-L, FRONT-R, SUR-L, SUR-R, CENTER > EQ (EQ Type = GEQ)" (p. 16) parameters of each speaker are set automatically based on the measurement of the room acoustics.

1. Follow this sequence of steps: [MIC] + [MUSIC] (SYSTEM) buttons → "Room Acoustic Control" → [ENTER] button.

The "RAC Entry" screen appears.

2. Connect a microphone for measurement to a MIC jack (any one of MIC 1–4) and place the microphone at the main listening position.

MEMO

Use a commercially available microphone for the measurement.

3. Press the [ENTER] button.

The "RAC Setting1" screen appears.

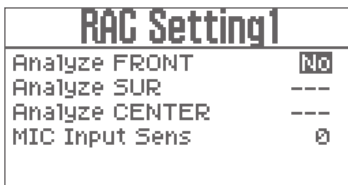

4. Select the channels that you want to analyze.

Parameter	Value	Explanation
Analyze FRONT	No, Yes	Analyze the FRONT-L and FRONT-R speakers and perform the correction.
Analyze SUR	No, Yes	Analyze the SUR-L and SUR-R speakers and perform the correction.
Analyze CENTER	No, Yes	Analyze the CENTER speaker and perform the correction.
MIC Input Sens	-4--+4	Adjust the input sensitivity for MIC.

MEMO

You can only select channels that are specified by the OUTPUT parameter "Output Channel" (p. 15).

5. Press the [ENTER] button.

The "RAC Setting2" screen appears.

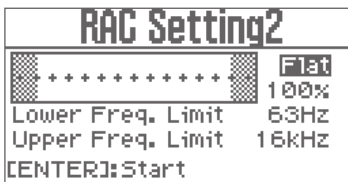

6. Set the parameters.

Parameter	Value	Explanation
Response Curve	Select the response curve to be used as the reference for adjustment.	
	Flat	Flat response.
	Bump	Response curve that boosts the low and high-frequency regions, producing the so-called "scooped" sound.
	Warm	Response curve that boosts the mid-range, producing a rich and warm sound.
Response Curve Amplitude	70%–130%	Sets the sharpness of the response curve. Higher values emphasize the response.
Lower Freq. Limit	40Hz, 63Hz, 100Hz	Sets the lower cut-off frequency for measuring the room acoustics.
Upper Freq. Limit	16kHz, 20kHz	Sets the upper cut-off frequency for measuring the room acoustics.

7. Press the [ENTER] button.

A test signal will be emitted from the speakers for which you chose "Yes" in step 4.

8. Use the [VALUE] knob to adjust the volume of the test signal from the speakers.

Raise the volume if the screen displays "Turn Up Level" and lower the volume if the screen displays "Turn Down Level."

When the volume is adjusted to the appropriate level, the unit displays "Measuring..." on the screen and starts the measurement.

When measurement for one speaker has been completed, measurement for the next speaker will begin. When all measurements have been completed, the screen will indicate "Completed."

MEMO

- Keep noise away from the microphone and refrain from talking during the measurement.
- If you decide to cancel the measurement, press the [EXIT] button and proceed as directed by the screen.

9. To proceed to the next step, press the [EXIT] button. If you want to redo the measurement, press the [ENTER] button and repeat the procedure from step 4.

10. Disconnect the microphone that you used for measurement, and connect the microphone that you'll be using for vocals.

11. Press the [ENTER] button.

12. Adjust the MIC Master Level.

MEMO

The MIC Master Level is the same as the MIC parameter in the top screen (p. 9).

13. Press the [ENTER] button.

This completes room acoustics compensation.

Automatically Switching the Input Signal

The KSP-100 can detect signals input to the INPUT (KARAOKE, AUX 1, or AUX 2) jacks and automatically switch the INPUT jack used, according to the priority.

1. In the top screen, move the cursor to "INPUT SELECT."
2. Set the "INPUT SELECT" (p. 9) to "Auto."

MEMO

For more information, see "KARAOKE Auto Sel", "AUX1 Auto Sel", and "AUX2 Auto Sel" (p. 17).

Priority of INPUT jacks

When the "INPUT SELECT" (p. 9) is set to Auto, and there are inputs to multiple INPUT jacks, the INPUT jack is selected automatically according to the priority setting.

Example:

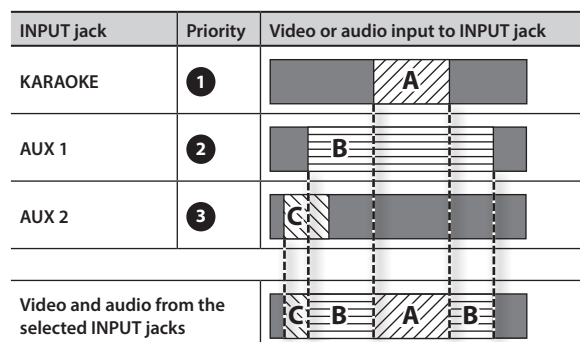

* The horizontal axis represents elapsed time.

Changing How Switching Occurs When High-priority Signals are Input

Here's how to change the way that signals will be switched when a signal is input to a jack that has higher priority than the currently selected INPUT jack.

1. Set the SYSTEM parameter "AUX1 Input Type" or "AUX2 Input Type" (p. 17) to "KARAOKE" or "BGM."

Relationship between the signals of the INPUT jacks and the signal that is selected

Example 1:

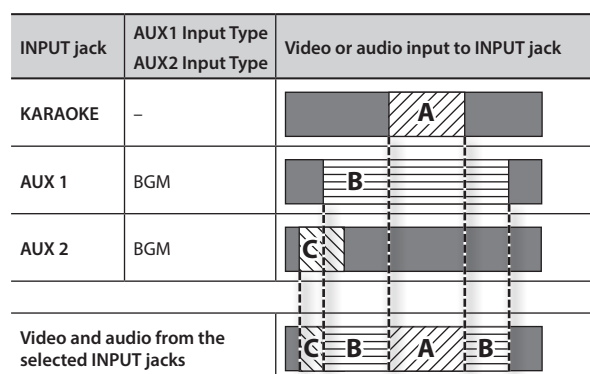

Example 2:

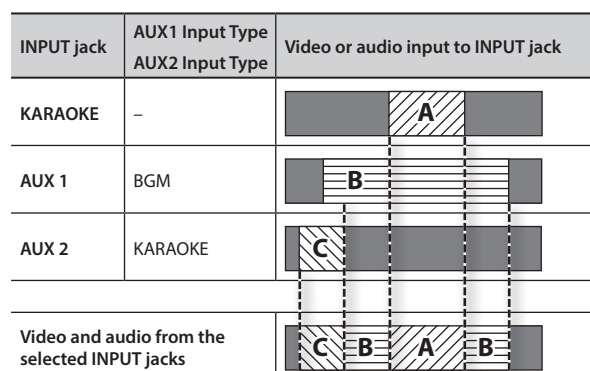

* The horizontal axis represents elapsed time.

Preventing Acoustic Feedback (Static Anti-Feedback)

Acoustic feedback can be reduced by measuring in advance the frequency of the acoustic feedback that is likely to occur.

1. Connect a vocal microphone to a MIC jack (any one of MIC 1–4) and place it at the singing position.
2. Follow this sequence of steps: [MIC] + [MUSIC] (SYSTEM) buttons → “Anti-Feedback” → [ENTER] button.

The “Anti-Feedback” screen appears.



3. Set the “Static Filter Switch” to “On.”
4. Follow this sequence of steps: “Static Filter Setting” → [ENTER] button.

The “Static Filter” screen appears.

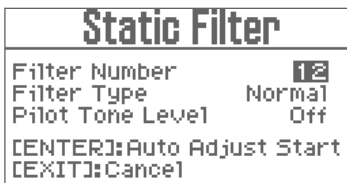

5. Set the parameters.

Parameter	Value	Explanation
Filter Number	2, 4, 6, 8, 10, 12	If there are multiple frequencies at which acoustic feedback is likely to occur, then set the number of frequencies (number of filters) you want to save.
Filter Type	Select the Filter Type.	
	Wide	Increases the anti-feedback effect.
	Normal	Provides the anti-feedback effect with less change in tone.
Pilot Tone Level	Off, -36–0dB	Sets the output level of the measurement signal. If this is set to anything other than “Off,” a measurement signal will be output from the speakers.

6. Press the [ENTER] button.
The message “Filter is made automatically. Are you sure?” appears.

7. Press the [ENTER] button.
The unit displays “Measuring...” on the screen and starts the measurement.

When measurement is completed, the display will indicate “Completed” and measurement signal output will stop.

MEMO

- Keep noise away from the microphone and refrain from talking during the measurement.
- If the anti-feedback function is not enough to suppress feedback, take the following steps
 - Change the direction of the microphones
 - Move the microphones away from the speakers
 - Lower the volume

Locking Parameters to Prevent Changes (Panel Lock)

Unintended changes to the settings can be prevented by setting the Panel Lock to “On.”

1. Follow this sequence of steps: [MIC] + [MUSIC] (SYSTEM) buttons → “Panel Lock” → [ENTER] button.

The “Panel Lock” screen appears.



2. Press the [ENTER] button.
KSP-100 displays “Completed” on the screen and the Panel Lock is turned “On.” If there is an attempt to change a parameter in this state, “Panel Locked” is displayed on the screen.

Releasing Panel Lock

This releases the Panel Lock, allowing you to make changes to or use the parameters.

1. Hold down the [EXIT] button for more than two seconds.

Returning the KSP-100’s Settings to Default Factory Settings (Factory Reset)

Here’s how to restore the parameters in the KSP-100 to their original default factory settings.

1. Follow this sequence of steps: [MIC] + [MUSIC] (SYSTEM) buttons → “Factory Reset” → [ENTER] button.

The “Factory Reset” screen appears.



2. Set the parameters.

Parameter	Value	Explanation
Factory Reset	All	All parameters will be restored to their default setting.
	SYSTEM	The system parameters will be restored to their default settings.

3. Press the [ENTER] button.
The message “Are you sure?” appears.

NOTE

If you restore the default factory settings, previously saved settings will be lost.

4. To return to the default factory settings, Press the [ENTER] button.

The settings will return to the default factory settings.

Changing the Settings

Press the buttons shown below to change the settings of the KSP-100. See the following pages for more information.

Setting	Operation	Page
MIC Parameters	Press the [MIC] button.	p. 13
MUSIC Parameters	Press the [MUSIC] button.	p. 15
OUTPUT Parameters	Press the [OUTPUT] button.	p. 15
SYSTEM Parameters	Press the [MIC] + [MUSIC] (SYSTEM) buttons.	p. 16

For information on the relationship between the parameters and signal flow, see "Block Diagram" (p. 19).

MEMO

Noise Suppressor

Parameter	Value	Explanation
Switch	Off, On	Noise suppressor switch
Threshold	0-100	Volume at which noise suppression begins.

For parameters shown with a gray background (prefixed by ▼ in the display), you can move the cursor to that parameter and press the [ENTER] button to access advanced settings.

* However, the advanced setting screen will not appear if the setting is "Off"
Press the [EXIT] button to go back to the previous screen.



Setting the MIC Parameters

Parameter	Value	Explanation
MIC Direct Level	0-100	MIC direct level

MIC1/2, MIC3/4

Parameter	Value	Explanation
Input Level	Mute, -63.0 dB-0.0 dB	Input level
Low Cut Freq.	Flat, 20.0 Hz-1.00 kHz	Low cut frequency
EQ Type	PEQ, GEQ	Select EQ type

MIC1/2, MIC3/4 > Noise Suppressor

Parameter	Value	Explanation
Switch	Off, On	Noise Suppressor switch
Threshold	0-100	Volume at which noise suppression begins.
Release	0-100	Time from when noise suppression begins until the volume reaches zero.

MIC1/2, MIC3/4 > Compressor

Parameter	Value	Explanation
Switch	Off, On	Compressor switch
Attack	0-100	Speed at which compression starts.
Release	0-100	Time from when the volume falls below the threshold level until the compressor effect is no longer applied.
Threshold	0-100	Volume level at which compression begins.
Ratio	1.00:1-16.0:1, Inf:1	Compression ratio
Post Gain	0 dB-+18 dB	Output gain
Output Level	0-100	Output level

MIC1/2, MIC3/4 > EQ (EQ Type = GEQ)

Parameter	Value	Explanation
Switch	Off, On	EQ switch
BAND1 Gain	-12 dB-+12 dB	Gain
:		
BAND15 Gain	-12 dB-+12 dB	Gain

MIC1/2, MIC3/4 > EQ (EQ Type = PEQ)

Parameter	Value	Explanation
Switch	Off, On	EQ switch
BAND1 Type	Shelving, Peaking	Filter type
BAND1 Freq.	20.0 Hz-20.0 kHz	Frequency
BAND1 Gain	-12 dB-+12 dB Gain	Gain
BAND1 Q	0.3-16	Bandwidth. Higher values make the band narrower.
BAND2 Freq.	20.0 Hz-20.0 kHz	Frequency
BAND2 Gain	-12 dB-+12 dB Gain	Gain
BAND2 Q	0.3-16	Bandwidth. Higher values make the band narrower.
:		
BAND15 Q	0.3-16	Bandwidth. Higher values make the band narrower.

Echo

Parameter	Value	Explanation
Delay Level	0-100	Delay output level
Delay Type	Digital Delay, Tape Echo	Delay type
Reverb Level	0-100	Reverb output level

Changing the Settings

Echo > Delay (Delay Type = Digital Delay)

Parameter	Value	Explanation
Send Level	0–100	Delay send level
Pre-Delay Time	0 ms–250 ms	Delay time inserted at the beginning of the digital delay
Delay Time	4 ms–500 ms	Time interval between repeats of the delay sound
Delay Feedback	0–100	Amount of repeated delay sound
Sub Delay Time	0%–100%	Timing of the Sub Delay sound (as a proportion of the Delay Time)
Sub Delay Level	0–100	Volume of the Sub Delay sound
L-ch Tap	0%–100%	Timing at which the first delay sound of the L-channel is heard (as a proportion of the Delay Time)
R-ch Tap	0%–100%	Timing at which the first delay sound of the R-channel is heard (as a proportion of the Delay Time)
LF Damp	Flat, 20.0 Hz–4.00 kHz	Frequency at which the low-frequency portion of the feedback sound is attenuated
HF Damp	2.00 kHz–20.0 kHz, Flat	Frequency at which the high-frequency portion of the feedback sound is attenuated
Low Cut	Flat, 20.0 Hz–1.00 kHz	Frequency at which the low-frequency portion is cut
High Cut	1.00 kHz–20.0 kHz, Flat	Frequency at which the high-frequency portion is cut
Dly to Rvb Level	0–100	Volume of the delay sound that is sent to reverb

Echo > Delay (Delay Type = Tape Echo)

Parameter	Value	Explanation
Send Level	0–100	Delay send level
Tape Echo Mode	S, M, L, S+M, S+L, M+L, S+M+L	Combination of playback heads that are used. Select from the following combinations of three playback heads, each with different delay times. S: Short M: Middle L: Long
Head S Pan	L50–Center–50R	Panning of each playback head (short, middle, long)
Head M Pan	L50–Center–50R	
Head L Pan	L50–Center–50R	
Repeat Rate	0–100	Tape speed
Intensity	0–100	Amount of repeated delay sound
Wow/Flutter Rate	0–100	Speed and depth of the complex pitch instability caused by tape aging and unstable rotation
Wow/Flutter Depth	0–100	
Bass	-12 dB–+12 dB	Amount of boost/cut for the low-frequency portion
Treble	-12 dB–+12 dB	Amount of boost/cut for the high-frequency portion
Low Cut	Flat, 20.0 Hz–1.00 kHz	Frequency at which the low-frequency portion is cut
High Cut	1.00 kHz–20.0 kHz, Flat	Frequency at which the high-frequency portion is cut
Dly to Rvb Level	0–100	Volume of the delay sound that is sent to reverb

Echo > Delay EQ

Parameter	Value	Explanation
Switch	Off, On	EQ switch
BAND1 Type	Shelving, Peaking	Filter type
BAND1 Freq.	20.0 Hz–20.0 kHz	Frequency
BAND1 Gain	-12 dB–+12 dB	Gain
BAND1 Q	0.3–16	Bandwidth. Higher values make the band narrower.
BAND2 Freq.	20.0 Hz–20.0 kHz	Frequency
BAND2 Gain	-12 dB–+12 dB	Gain
BAND2 Q	0.3–16	Bandwidth. Higher values make the band narrower.
BAND3 Freq.	20.0 Hz–20.0 kHz	Frequency
BAND3 Gain	-12 dB–+12 dB	Gain
BAND3 Q	0.3–16	Bandwidth. Higher values make the band narrower.
BAND4 Type	Shelving, Peaking	Filter type
BAND4 Freq.	20.0 Hz–20.0 kHz	Frequency
BAND4 Gain	-12 dB–+12 dB	Gain
BAND4 Q	0.3–16	Bandwidth. Higher values make the band narrower.

Echo > Reverb

Parameter	Value	Explanation
Send Level	0–100	Reverb send level
Type	Room, Hall1, Hall2, Hall3, Plate	Reverb type
Size	0–100	Length of reverb sound
Pre-Delay Time	0–127	Time until the reverb sound is first heard
Tone Gain	-12 dB–+12 dB	Amount of boost/cut for the high-frequency portion of the reverb
HF Damp	2.00 kHz–20.0 kHz, Flat	Frequency at which the high-frequency portion of the reverb is attenuated
Low Cut	Flat, 20.0 Hz–1.00 kHz	Frequency at which the low-frequency portion is cut
High Cut	1.00 kHz–20.0 kHz, Flat	Frequency at which the high-frequency portion is cut

Echo > Reverb EQ

Parameter	Value	Explanation
Switch	Off, On	EQ switch
BAND1 Type	Shelving, Peaking	Filter type
BAND1 Freq.	20.0 Hz–20.0 kHz	Frequency
BAND1 Gain	-12 dB–+12 dB	Gain
BAND1 Q	0.3–16	Bandwidth. Higher values make the band narrower.
BAND2 Freq.	20.0 Hz–20.0 kHz	Frequency
BAND2 Gain	-12 dB–+12 dB	Gain
BAND2 Q	0.3–16	Bandwidth. Higher values make the band narrower.
BAND3 Freq.	20.0 Hz–20.0 kHz	Frequency
BAND3 Gain	-12 dB–+12 dB	Gain
BAND3 Q	0.3–16	Bandwidth. Higher values make the band narrower.
BAND4 Type	Shelving, Peaking	Filter type
BAND4 Freq.	20.0 Hz–20.0 kHz	Frequency
BAND4 Gain	-12 dB–+12 dB	Gain
BAND4 Q	0.3–16	Bandwidth. Higher values make the band narrower.

Setting the MUSIC Parameters

The following parameters allow you to adjust the tone quality of the signals input to AUDIO INPUT's KARAOKE, AUX 1, and AUX 2 jacks.

Parameter	Value	Explanation
KARAOKE Level	Mute, -63.0 dB–0.0 dB	KARAOKE input level
AUX1 Level	Mute, -63.0 dB–0.0 dB	AUX 1 input level
AUX2 Level	Mute, -63.0 dB–0.0 dB	AUX 2 input level
EQ Type	PEQ, GEQ	Select EQ type

Noise Suppressor

Parameter	Value	Explanation
Switch	Off, On	Noise Suppressor switch
Threshold	0–100	Volume at which noise suppression begins.
Release	0–100	Time from when noise suppression begins until the volume reaches zero.

Compressor

Parameter	Value	Explanation
Switch	Off, On	Compressor switch
Attack	0–100	Speed at which compression starts.
Release	0–100	Time from when the volume falls below the threshold level until the compressor effect is no longer applied.
Threshold	0–100	Volume level at which compression begins.
Ratio	1.00:1–16.0:1, Inf:1	Compression ratio
Post Gain	0–+18 dB	Output gain
Output Level	0–100	Output level

EQ (EQ Type = GEQ)

Parameter	Value	Explanation
Switch	Off, On	EQ switch
BAND1 Gain	-12 dB–+12 dB	Gain
:		
BAND15 Gain	-12 dB–+12 dB	Gain

EQ (EQ Type = PEQ)

Parameter	Value	Explanation
Switch	Off, On	EQ switch
BAND1 Type	Shelving, Peaking	Filter type
BAND1 Freq.	20.0 Hz–20.0 kHz	Frequency
BAND1 Gain	-12 dB–+12 dB	Gain
BAND1 Q	0.3–16	Bandwidth. Higher values make the band narrower.
BAND2 Freq.	20.0 Hz–20.0 kHz	Frequency
BAND2 Gain	-12 dB–+12 dB	Gain
BAND2 Q	0.3–16	Bandwidth. Higher values make the band narrower.
:		
BAND15 Q	0.3–16	Bandwidth. Higher values make the band narrower.

Setting the OUTPUT Parameters

The following parameters allow you to set the HANAMICHI effect and adjust the sound that emanates from the speakers.

Parameter	Value	Explanation
Output Channel	2ch	Select this option when the FRONT-L and FRONT-R speakers are connected.
	3ch	Select this option when the FRONT-L, FRONT-R and CENTER speakers are connected.
	4ch	Select this option when the FRONT-L, FRONT-R, SUR-L and SUR-R speakers are connected.
	5ch	Select this option when the FRONT-L, FRONT-R, SUR-L, SUR-R and CENTER speakers are connected.
HANAMICHI Switch	Off, On, Auto	HANAMICHI effect switch Off: The HANAMICHI effect is not applied. On: The HANAMICHI effect is applied at all times. Auto: The HANAMICHI effect is applied according to the MIC input.
HANAMICHI Width	1–3	Adjusts the soundscape.
HANAMICHI Depth	1–6	Adjusts the amount of reverberation.

FRONT-L / FRONT-R / SUR-L / SUR-R / CENTER

Parameter	Value	Explanation
Output Level	Mute, -63.0 dB–0.0 dB	Output level
MIC Direct Level	0–100	MIC direct level
MIC Echo Level	0–100	MIC echo level
MUSIC Level	0–100	MUSIC level
HANAMICHI Level	0–100	Adjusts the MUSIC volume when the HANAMICHI effect is being applied.

SUBWOOFER

Parameter	Value	Explanation
Output Level	Mute, -64.0 dB–+6.0 dB	Output level
Phase	Normal, Inverse	Phase of signal
MIC Direct Level	0–100	MIC direct level
MIC Echo Level	0–100	MIC echo level
MUSIC Level	0–100	MUSIC level
HANAMICHI Level	0–100	Adjusts the MUSIC volume when the HANAMICHI effect is being applied.

Setting the SYSTEM Parameters

The following parameters allow you to make the system settings for KSP-100.

Room Acoustic Control

For more information, see “Compensating for the Room Acoustics (Room Acoustic Auto Control)” (p. 10).

Output EQ > FRONT-L, FRONT-R, SUR-L, SUR-R, CENTER

Parameter	Value	Explanation
Low Cut Freq.	Flat, 20.0 Hz–1.00 kHz	Low-cut frequency
EQ Type	PEQ, GEQ	Select EQ type

Output EQ > FRONT-L, FRONT-R, SUR-L, SUR-R, CENTER > EQ (EQ Type = GEQ)

Parameter	Value	Explanation
Switch	Off, On	EQ switch
BAND 1 Gain	-12 dB–+12 dB	Gain
:		
BAND 15 Gain	-12dB–+12 dB	Gain

Output EQ > FRONT-L, FRONT-R, SUR-L, SUR-R, CENTER > EQ (EQ Type = PEQ)

Parameter	Value	Explanation
Switch	Off, On	EQ switch
BAND 1 Type	Shelving, Peaking	Filter type
BAND 1 Freq.	20.0 Hz–20.0 kHz	Frequency
BAND 1 Gain	-12 dB–+12 dB	Gain
BAND 1 Q	0.3–16	Bandwidth. Higher values make the band narrower.
BAND 2 Freq.	20.0 Hz–20.0 kHz	Frequency
BAND 2 Gain	-12 dB–+12 dB	Gain
BAND 2 Q	0.3–16	Bandwidth. Higher values make the band narrower.
:		
BAND 15 Q	0.3–16	Bandwidth. Higher values make the band narrower.

Output EQ > SUBWOOFER

Parameter	Value	Explanation
Low Cut Type	6 dB Butter–24 dB Link-R	Low-cut filter type
Low Cut Freq.	Flat, 20.0 Hz–1.00 kHz	Low-cut frequency
High Cut Type	6 dB Butter–48 dB Link-R	High-cut filter type
High Cut Freq.	35.0 Hz–2.00 kHz	High-cut frequency
Delay Time	0.0 ms–50.0 ms	Delay time

Output EQ > SUBWOOFER > EQ

Parameter	Value	Explanation
Switch	Off, On	EQ switch
BAND1 Type	Shelving, Peaking	Filter type
BAND1 Freq.	20.0 Hz–20.0 kHz	Frequency
BAND1 Gain	-12 dB–+12 dB	Gain
BAND1 Q	0.3–16	Bandwidth. Higher values make the band narrower.
BAND2 Freq.	20.0 Hz–20.0 kHz	Frequency
BAND2 Gain	-12 dB–+12 dB	Gain
BAND2 Q	0.3–16	Bandwidth. Higher values make the band narrower.
BAND3 Freq.	20.0 Hz–20.0 kHz	Frequency
BAND3 Gain	-12 dB–+12 dB	Gain
BAND3 Q	0.3–16	Bandwidth. Higher values make the band narrower.
BAND4 Type	Shelving, Peaking	Filter type
BAND4 Freq.	20.0 Hz–20.0 kHz	Frequency
BAND4 Gain	-12 dB–+12 dB	Gain
BAND4 Q	0.3–16	Bandwidth. Higher values make the band narrower.

Output EQ > SUBWOOFER > Compressor

Parameter	Value	Explanation
Switch	Off, On	Compressor switch
Attack	0–100	Speed at which compression starts.
Release	0–100	Time from when the volume falls below the threshold level until the compressor effect is no longer applied.
Threshold	0–100	Volume level at which compression begins.
Ratio	1.00:1–16.0:1, Inf:1	Compression ratio
Post Gain	0 dB–+18 dB	Output gain
Output Level	0–100	Output level

Anti-Feedback

Parameter	Value	Explanation
Diffuse Level	Off, 1–5	Slightly modulates the pitch of the MIC input to suppress unwanted acoustic feedback.
Dynamic Filter Switch	Off, On	Anti-Feedback switch. When set to “On,” the KSP-100 detects sudden acoustic feedback and suppresses it.
Dynamic Filter Release	0–16	Amount of time the anti-feedback effect is maintained

For more information, see “Preventing Acoustic Feedback (Static Anti-Feedback)” (p. 12).

Input Setting

Parameter	Value	Explanation
KARAOKE Auto Sel AUX1 Auto Sel AUX2 Auto Sel		Specifies the behavior of the INPUT jacks when the INPUT SELECT parameter in the top screen is set to "Auto" (p. 9, p. 11).
	A&V	Selects the INPUT jack when an audio or video signal input is detected.
	Audio	Selects the INPUT jack when an audio signal input is detected.
	Video	Selects the INPUT jack when a video signal input is detected.
KARAOKE Sens AUX1 Sens AUX2 Sens	Low, Mid, High	Set the sensitivity at which each audio input level is detected and switched automatically.
AUX1 Input Type AUX2 Input Type		Change the priority of the AUX 1 and AUX 2 jacks when the "INPUT SELECT" (p. 9) is set to "Auto." For more information, see "Changing How Switching Occurs When High-priority Signals are Input" (p. 11).
	KARAOKE	If the signal to the jack set to "KARAOKE" is enabled (i.e., if the jack is selected), then the "INPUT SELECT" (p. 9) will not switch until the signal input to the jack set to "KARAOKE" ceases, even if a signal having a higher priority has arrived.
	BGM	If the input of a signal with higher priority is detected, then the input switches to that signal immediately.
	MIC	Uses the jacks as MIC input. Use this setting when you connect wireless receivers (sold separately). The input does not switch based on priority.
Release Time(Video)	0 sec–5 sec	Sets the time from when there is no more video signal to the VIDEO INPUT jack currently selected until the video switches to another VIDEO INPUT jack.
Release Time(Audio)	0 sec–5 sec	Sets the time from when there is no more audio signal to the AUDIO INPUT jack currently selected until the audio switches to another AUDIO INPUT jack.

Maximum Level

Parameter	Value	Explanation
MASTER Level	Mute, -64.0 dB–+6.0 dB	Specifies an upper limit for the "MASTER" (p. 9) setting.
MUSIC Level	Mute, -64.0 dB–+6.0 dB	Specifies an upper limit for the "MUSIC" (p. 9) setting.
MIC Level	Mute, -64.0 dB–+6.0 dB	Specifies an upper limit for the "MIC" (p. 9) setting.

Key Control Setting

Parameter	Value	Explanation
Reset Level	-60 dB–0 dB	The KEY setting returns to h when the input signal stays lower than the volume specified by this Reset Level for a duration longer than specified by the Reset Time.
Reset Time	0 sec–60 sec	

MIC3/4 Bypass Switch

Parameter	Value	Explanation
MIC3/4 Bypass Switch	Off, On	When this is set to "On," the microphone effect is disabled for MIC 3 and MIC 4 jacks.

HANAMICHI MIC Sens

Parameter	Value	Explanation
HANAMICHI MIC Sens	1–5	Adjusts the depth of HANAMICHI effect. Higher values deepen the effect even if the MIC input is low. This parameter takes effect only when the HANAMICHI switch (p. 15) is set to "Auto."

LCD Contrast

Parameter	Value	Explanation
LCD Contrast	0–10	Adjusts the contrast of the display.

Top Screen Design

Parameter	Value	Explanation
Top Screen Design	Type1–Type4	Switches the type of top screen (the screen displayed when the power is turned on or when [EXIT] is pressed a number of times).

Scene Lock

Parameter	Value	Explanation
Scene Lock	Off, On	If this parameter is "On," scene changes via the remote control will be disabled.

Echo Lock

Parameter	Value	Explanation
Echo Lock	Off, On	If this parameter is "On," Echo type changes via the remote control will be disabled.

Input Select Lock

Parameter	Value	Explanation
Input Select Lock	Off, On	If this parameter is "On," INPUT jack switching via the remote control will be disabled.

Startup Scene

Parameter	Value	Explanation
Startup Scene	Last	The unit will start up with the scene number that was last selected before the power was turned off.
	P1–P9, U1–U9	The unit will start up with the selected scene number.

Startup Echo

Parameter	Value	Explanation
Startup Echo	Last	The unit will start up with the Echo type that was last selected before the power was turned off.
	P1–P9, U1–U9	The unit will start up with the selected Echo type.

Panel Lock

For more information, see "Locking Parameters to Prevent Changes (Panel Lock)" (p. 12).

Changing the Settings

Scene Save

For more information, see "Saving Scenes/Echos" (p. 9).

Scene Erase

Erases the selected scene number (U1–U9).

Echo Save

For more information, see "Saving Scenes/Echos" (p. 9).

Echo Erase

Erase the selected echo number (U1–U9).

Remote Setting

Parameter	Value	Explanation
Scene #1–Scene #4	P1–P9, U1–U9	Assign the scene number to the [SCENE 1]–[SCENE 4] buttons of Remote Controller.
Echo #1–Echo #4	P1–P9, U1–U9	Assign the Echo type to the [ECHO 1]–[ECHO 4] buttons of Remote Controller.

Factory Reset

For more information, see "Returning the KSP-100's Settings to Default Factory Settings (Factory Reset)" (p. 12).

Information

Displays the version of the KSP-100's system program.

Appendix

Block Diagram

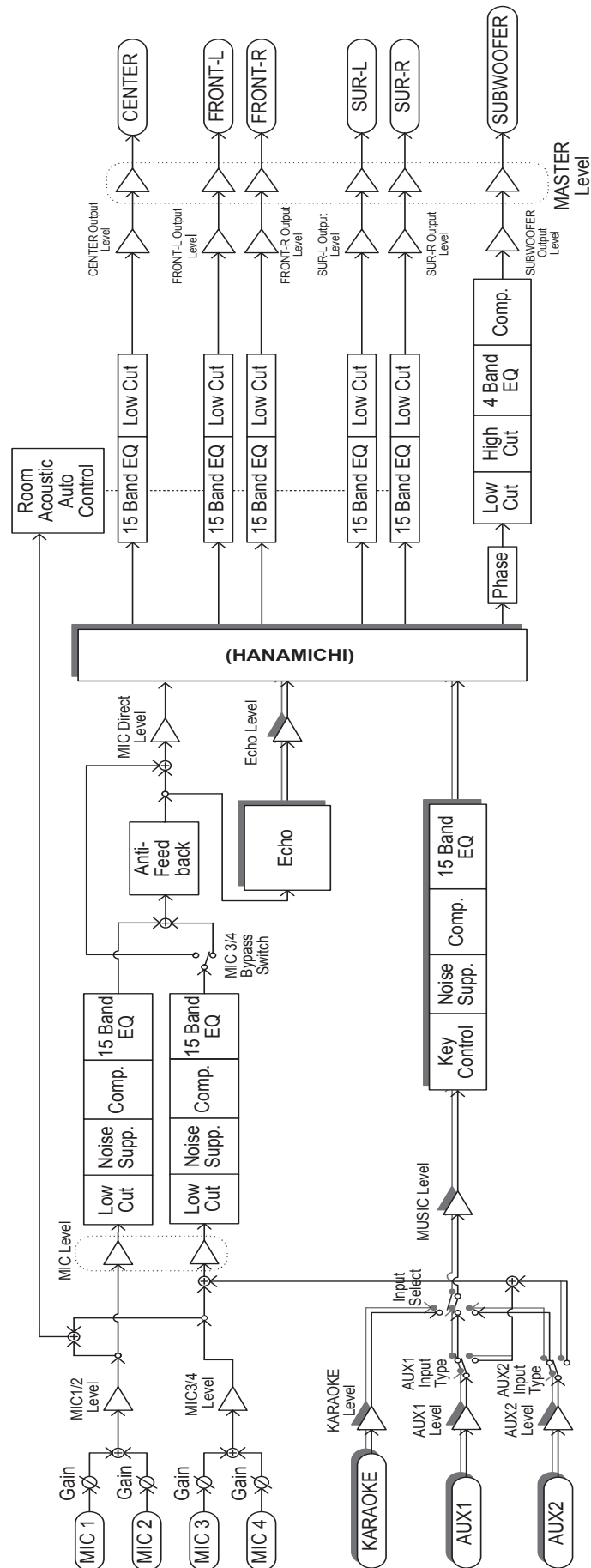

Specifications

BMB KSP-100: KARAOKE SOUND PROCESSOR

Nominal Input Level	MIC 1–MIC 4	-35– -10 dBu
	AUDIO INPUT (KARAOKE, AUX 1, AUX 2)	0 dBu
	VIDEO INPUT (KARAOKE, AUX 1, AUX 2)	1.0 Vp-p
Maximum Input Level	MIC 1–MIC 4	0 dBu
	AUDIO INPUT (KARAOKE, AUX 1, AUX 2)	+10 dBu
Input Impedance	MIC 1–MIC 4	7.5 kΩ
	AUDIO INPUT (KARAOKE, AUX 1, AUX 2)	20 kΩ
	VIDEO INPUT (KARAOKE, AUX 1, AUX 2)	75 Ω
Nominal Output Level	AUDIO OUTPUT (FRONT-L, FRONT-R, SUR-L, SUR-R, CENTER, SUBWOOFER)	+5 dBu
	VIDEO OUTPUT (1–3)	1.0 Vp-p (75 Ω)
Maximum Output Level	AUDIO OUTPUT (FRONT-L, FRONT-R, SUR-L, SUR-R, CENTER, SUBWOOFER)	+15 dBu
Output Impedance	AUDIO OUTPUT (FRONT-L, FRONT-R, SUR-L, SUR-R, CENTER, SUBWOOFER)	2 kΩ (Balanced)
	VIDEO OUTPUT (1–3)	75 Ω
Video Format	NTSC, PAL	
Connectors	MIC 1–MIC 4 jacks	1/4-inch phone type
	AUDIO OUTPUT (FRONT-L, FRONT-R, SUR-L, SUR-R, CENTER, SUBWOOFER) connectors	XLR type
	AUDIO INPUT KARAOKE (L, R) jacks	RCA phono type
	AUDIO INPUT AUX 1 (L, R) jacks	RCA phono type
	AUDIO INPUT AUX 2 (L, R) jacks	RCA phono type
	VIDEO INPUT (KARAOKE, AUX 1, AUX 2) jacks	Composite RCA phono type
	VIDEO OUTPUT (1–3) jacks	Composite RCA phono type
	CONTROL connector	DB-9 type
	EXT. R SENSOR connector	4-Pin mini DIN type
	USB port	USB Type B (MIDI)
	DC IN jack	
Display	Graphic LCD 128 x 64 dots	
Current Draw	600 mA	
Dimensions	420 (W) x 167 (D) x 44 (H) mm	
	16-9/16 (W) x 6-5/8 (D) x 1-3/4 (H) inches	
Weight	2.0 kg	
	4 lbs 7 oz	
Accessories	Owner's manual	
	AC adaptor	
	Registration card	

* 0 dBu = 0.775 Vrms

* In the interest of product improvement, the specifications and/or appearance of this unit are subject to change without prior notice.

For the U.K.

IMPORTANT: THE WIRES IN THIS MAINS LEAD ARE COLOURED IN ACCORDANCE WITH THE FOLLOWING CODE.

BLUE: NEUTRAL
BROWN: LIVE

As the colours of the wires in the mains lead of this apparatus may not correspond with the coloured markings identifying the terminals in your plug, proceed as follows:
The wire which is coloured BLUE must be connected to the terminal which is marked with the letter N or coloured BLACK.
The wire which is coloured BROWN must be connected to the terminal which is marked with the letter L or coloured RED.
Under no circumstances must either of the above wires be connected to the earth terminal of a three pin plug.

For EU Countries



This product complies with the requirements of EMC Directive 2004/108/EC.

For the USA

FEDERAL COMMUNICATIONS COMMISSION RADIO FREQUENCY INTERFERENCE STATEMENT

This equipment has been tested and found to comply with the limits for a Class B digital device, pursuant to Part 15 of the FCC Rules. These limits are designed to provide reasonable protection against harmful interference in a residential installation. This equipment generates, uses, and can radiate radio frequency energy and, if not installed and used in accordance with the instructions, may cause harmful interference to radio communications. However, there is no guarantee that interference will not occur in a particular installation. If this equipment does cause harmful interference to radio or television reception, which can be determined by turning the equipment off and on, the user is encouraged to try to correct the interference by one or more of the following measures:

- Reorient or relocate the receiving antenna.
- Increase the separation between the equipment and receiver.
- Connect the equipment into an outlet on a circuit different from that to which the receiver is connected.
- Consult the dealer or an experienced radio/TV technician for help.

This device complies with Part 15 of the FCC Rules. Operation is subject to the following two conditions:

- (1) this device may not cause harmful interference, and
- (2) this device must accept any interference received, including interference that may cause undesired operation.

This equipment requires shielded interface cables in order to meet FCC class B limit.

Any unauthorized changes or modifications not expressly approved by the party responsible for compliance could void the user's authority to operate the equipment.

For Canada

NOTICE

This Class B digital apparatus meets all requirements of the Canadian Interference-Causing Equipment Regulations.

AVIS

Cet appareil numérique de la classe B respecte toutes les exigences du Règlement sur le matériel brouilleur du Canada.

For C.A. US (Proposition 65)

WARNING

This product contains chemicals known to cause cancer, birth defects and other reproductive harm, including lead.

For the USA

DECLARATION OF CONFORMITY Compliance Information Statement

Model Name : KSP-100
Type of Equipment : Signal Processor
Responsible Party : ACE KARAOKE CORP.
Address : 161 S. 8th Ave., City of Industry, CA 91746, USA
Telephone : +1-626-600-5366

For Korea

B급 기기 (가정용 정보통신기기)

이 기기는 가정용으로 전자파적합등록을 한 기기
주거지역에서는 물론 모든지역에서 사용할 수 있

For EU Countries



- UK** This symbol indicates that in EU countries, this product must be collected separately from household waste, as defined in each region. Products bearing this symbol must not be discarded together with household waste.
- DE** Dieses Symbol bedeutet, dass dieses Produkt in EU-Ländern getrennt vom Hausmüll gesammelt werden muss gemäß den regionalen Bestimmungen. Mit diesem Symbol gekennzeichnete Produkte dürfen nicht zusammen mit den Hausmüll entsorgt werden.
- FR** Ce symbole indique que dans les pays de l'Union européenne, ce produit doit être collecté séparément des ordures ménagères selon les directives en vigueur dans chacun de ces pays. Les produits portant ce symbole ne doivent pas être mis au rebut avec les ordures ménagères.
- IT** Questo simbolo indica che nei paesi della Comunità europea questo prodotto deve essere smaltito separatamente dai normali rifiuti domestici, secondo la legislazione in vigore in ciascun paese. I prodotti che riportano questo simbolo non devono essere smaltiti insieme ai rifiuti domestici. Ai sensi dell'art. 13 del D.Lgs. 25 luglio 2005 n. 151.
- ES** Este símbolo indica que en los países de la Unión Europea este producto debe recogerse aparte de los residuos domésticos, tal como esté regulado en cada zona. Los productos con este símbolo no se deben depositar con los residuos domésticos.
- PT** Este símbolo indica que nos países da UE, a recolha deste produto deverá ser feita separadamente do lixo doméstico, de acordo com os regulamentos de cada região. Os produtos que apresentem este símbolo não deverão ser eliminados juntamente com o lixo doméstico.
- NL** Dit symbool geeft aan dat in landen van de EU dit product gescheiden van huishoudelijk afval moet worden aangeboden, zoals bepaald per gemeente of regio. Producten die van dit symbool zijn voorzien, mogen niet samen met huishoudelijk afval worden verwijderd.
- DK** Dette symbol angiver, at i EU-lande skal dette produkt opsamles adskilt fra husholdningsaffald, som defineret i hver enkelt region. Produkter med dette symbol må ikke smides ud sammen med husholdningsaffald.
- NO** Dette symbolet indikerer at produktet må behandles som spesialavfall i EU-land, iht. til retningslinjer for den enkelte regionen, og ikke kastes sammen med vanlig husholdningsavfall. Produkter som er merket med dette symbolet, må ikke kastes sammen med vanlig husholdningsavfall.

- SE** Symbolen anger att i EU-länder måste den här produkten kasseras separat från hushållsavfall, i enlighet med varje regions bestämmelser. Produkter med den här symbolen får inte kasseras tillsammans med hushållsavfall.
- FI** Tämä merkintä ilmaisee, että tuote on EU-maissa kerättävä erillään kotitalousjätteistä kunkin alueen voimassa olevien määräysten mukaisesti. Tällä merkinnällä varustettuja tuotteita ei saa hävittää kotitalousjätteiden mukana.
- HU** Ez a szimbólum azt jelenti, hogy az Európai Unióban ezt a terméket a háztartási hulladéktól elkülönítve, az adott régióban érvényes szabályozás szerint kell gyűjtteni. Az ezzel a szimbóllummal ellátott termékeket nem szabad a háztartási hulladék közé dobni.
- PL** Symbol oznacza, że zgodnie z regulacjami w odpowiednim regionie, w krajach UE produktu nie należy wyrzucać z odpadami domowymi. Produktów opatrzonych tym symbolem nie można utylizować razem z odpadami domowymi.
- CZ** Tento symbol udává, že v zemích EU musí být tento výrobek sbírán odděleně od domácího odpadu, jak je určeno pro každý region. Výrobky nesoucí tento symbol se nesmí vyhazovat spolu s domácím odpadem.
- SK** Tento symbol vyjadruje, že v krajinách EÚ sa musí zber tohto produktu vykonávať oddelene od domového odpadu, podľa nariadení platných v konkrétnej krajine. Produkty s týmto symbolom sa nesmú vyhazovať spolu s domovým odpadom.
- EE** See sümbol näitab, et EL-i maades tuleb see toode olemprügist eraldi koguda, nii nagu on igas piirkonnas määratletud. Selle sümboliga märgitud tooteid ei tohi ära visata koos olmeprügiga.
- LT** Šis simbolis rodo, kad ES šalyse šis produktas turi būti surenkamas atskirai nuo buitinių atliekų, kaip nustatyta kiekviename regione. Šiuo simboliu paženklinėti produktai neturi būti išmetami kartu su buitiniems atliekomis.
- LV** Šis simbols norāda, ka ES valstīs šo produktu jāievāc atsevišķi no mājsaimniecības atkritumiem, kā noteikts katrā reģionā. Produktus ar šo simbolu nedrīkst izmest kopā ar mājsaimniecības atkritumiem.
- SI** Ta simbol označuje, da je treba proizvod v državah EU zbirati ločeno od gospodinskih odpadkov, tako kot je določeno v vsaki regiji. Proizvoda s tem znakom ni dovoljeno odlagati skupaj z gospodinskimi odpadki.
- GR** Το σύμβολο αυτό υποδηλώνει ότι στις χώρες της Ε.Ε. το συγκεκριμένο προϊόν πρέπει να συλλέγεται χωριστά από τα υπόλοιπα οικιακά απορρίμματα, σύμφωνα με όσα προβλέπονται σε κάθε περιοχή. Τα προϊόντα που φέρουν το συγκεκριμένο σύμβολο δεν πρέπει να απορρίπτονται μαζί με τα οικιακά απορρίμματα.