

OWNER'S MANUAL

THANK YOU VERY MUCH FOR PURCHASING THIS **BMB** SPEAKERS SYSTEM.

READ THE INSTRUCTION MANUAL CAREFULLY BEFORE USING THIS SPEAKERS SYSTEM SO THAT YOU CAN OPERATE IT PROPERLY.

AFTER YOU HAVE FINISHED, PUT THIS MANUAL AWAY IN A SAFE PLACE FOR FUTURE REFERENCE.

MATTERS OF SAFETY FIRST







Based on security, before the correct use of this product, please carefully read through the instructions again. After reading, please keep it for future reference.

< MATTERS OF SAFETY FIRST > is to prevent harm to you or others, property loss, to a variety of pattern identification. The identification and significance of pattern, please fully understand before you continue reading.

 **WARNING** If ignore this logo, misuse, may cause serious injury or even death.



 **CAUTION** If ignore this logo, misuse, may cause damage of the goods or injuries.

PATTERN REPRESENTATION OF CASES

-   Mark is told to pay attention to the content (with a warning). Pattern of the intermediate drawing attention to concrete content (this description refers to the attention of electric shock).
-   Mark is to inform the prohibited acts. Pattern of intermediate describe specific content prohibited. (left picture it means no decomposition).
-   Mark is inform compulsive behavior, content. Pattern of the intermediate drawing indicates the specific content (this description refers to the power plug from the socket).

WARNING

■ FAULT STATE DO NOT CONTINUE TO USE

-   ● In case, continue to use the emergence of smoke, odor, noise and other abnormal condition, will cause fire, electric shock, amplifier fault. Immediately turn off the amplifier, must pull out the power plug from the socket. Confirmation until stopped smoking, to rely on sales shop.

■ DO NOT TRANSFORMATION



-  ● Don't alter or decomposition of the products. May result in fire, electric shock.

■ DON NOT PUT IN THE POSITION OF WATER



-  ● This product can not be water, do not get wet. Water, wet may result in fire, electric shock. In the rainy day, snow day, coast, water use should be paid special attention to the.

■ CANNOT BE WATER CONTAINERS ARE PLACED

-  ● Don't use a vase, potted plant, glass, cosmetics, pharmaceuticals, container with water and small metal items in the product. The water spill, into the inside of the machine will cause fire, electric shock.

-   ● In case of the machine, water, immediately turn off the amplifier, unplug the power plug from the socket, and then contact the sales shop. Continue to use, will cause fire, electric shock.

■ DON NOT BE FOREIGN BODY INTO THE INTERIOR

-   ● In case, foreign body into the machine, turn off the amplifier power, unplug the power plug from the socket, and then contact the sales shop. Continue to use, will cause fire, electric shock.

CAUTION

■ INSTALLING



- Can not be placed in the shaking of the table upper unstable place. Falling down, falling down can lead to injuries.



- Move the product, do not hand grasping the iron net, the speaker unit. May cause injury.



- Moving the product, turn off the amplifier, unplug the power plug from the socket, remove the speaker cable and mobile. Or will lead to cable damage, cause fire, electric shock.



- The product is placed on TV, audio equipment, do not move the product. Articles collapse cause injury.



- This product can not be placed over 10kg weight and ratio of large size items. The imbalance will make the goods fall, fall and hurt.

■ CAN NOT SET IN THE FOLLOWING AREAS



- Can not be placed in the food processing machine, humidifier, steam soot place. May result in fire, electric shock.



- Can not be placed in damp, dusty places. May result in fire, electric shock.

■ ON CONNECTION



- The machine and other audio equipment, television sets and other machine connection, please read carefully the instructions of each machine, Switch off the power supply, follow the instructions.

■ NOTE AT WHEN USING



- Switch on the power set the volume to a minimum. All of a sudden loud noise can cause hearing impairment.



- Don't use long time voice distortion under the state. The speaker fever will cause fire



- Please don't sit on or suspended in the loudspeaker. Special attention should be paid to the child. Collapse, damage can result in injury.



- Cash card, disk with magnetic products do not close. The speaker magnetic will affect the products, the use of data Disappear.

INSTALLING THE SPEAKERS

- This equipment should only be installed by a suitably experienced and qualified person. Is in no way responsible for accidents, injury or damage caused by incorrect installation/setting up, misuse, modification or natural disasters.
- Before wall- or ceiling-mounting this speaker, please make sure that the wall or ceiling is strong enough to support the speaker's weight (16.9 kg). If you are in doubt, please consult a specialist. Serious injury could result if the speaker were to fall.
- Three M10 diameter screw holes for mounting the speaker can be found on the top. There are also Ø36 holes on the bottom panel; please remove the caps before use.
- If you are using a stand, metal fittings, etc. with the speaker, please make sure that they are of sufficient strength to carry the load.
- A carrying handle is provided on the both side of the speaker (when horizontal). Use this if you need to move the speaker short distances.
- Avoid installing the speakers in a location exposed to direct sunlight and high levels of humidity. Avoid also locations in the vicinity of stoves and other sources of heat.
- For optimum sound reproduction of high frequencies, the treble speaker units must be at the same height as the listener's ears.
- For low frequencies, it is possible to increase the level of bass sounds by positioning the speakers close to a wall (the maximum increase being obtained for a position in a corner of the listening room).
- This speaker system is not magnetically shielded. However, depending on the installation location, color distortion may occur if the speaker system is installed extremely close to the screen of a television set. If this happens, turn off the television, then turn it on again after 15 to 30 minutes. If the problem persists, place the speaker system away from the television set.

BEFORE USE

- The rated impedance of this speaker system is $8\ \Omega$. It must be connected to an amplifier which accepts this type of load (minimum and maximum impedances accepted by the amplifier are generally indicated near the loudspeaker outlets: for example " $4\ \Omega$ - $16\ \Omega$ " or " $6\ \Omega$ - $16\ \Omega$ ").
- The maximum input power of these speakers is 1200 W (at peak). Higher levels of input power may cause damage to the speaker system and so take every precaution to keep the power down to the specification.
- Any connection or switching on or off of part of the audio system (CD player, tuner etc.) must be carried out after switching off the amplifier or at least with the loudspeaker outlets disconnected (if the amplifier allows). Interference caused by these operations will otherwise reach the speaker and may damage the treble loudspeaker units.
- Do not force a low-power amplifier to produce a high level of sound as harmonic distortion increases rapidly in this situation and may pose a danger to the treble speaker units.
- When boosting particular frequencies using a graphic equaliser or bass and treble correctors, make sure that you do not increase the amplifier volume excessively, as the speaker will be overloaded more quickly.
- Avoid touching the diaphragms and suspensions of speaker units as they are fragile.

CONNECT TO AMPLIFIER

There are two connection terminals on the rear side of the speaker. The speaker's terminals are exactly the same; use whichever is convenient.

- ⊘ Be careful not to short the two pins of the free speaker terminal. Doing so could damage the speaker and/or your amplifier.
- ⊘ After connecting the plugs, pull lightly on the cables to make sure that the ends of the cables are securely connected to the terminals.
- ⊘ Poor connections can create noise and interruptions in the sound.
- ⊘ If the cables' wires happen to be pushed out of the terminals, allowing the wires to come into contact with each other, it places an excessive additional load on the amplifier. This may cause the amplifier to stop functioning, and may even damage the amplifier.

To connect the speaker to your amplifier you will need a suitable speaker cord terminated in a Neutrik Speakon® speaker connector [NL4MP]. Only the 1+ and 1- pins should be connected. These connect to the positive (+) and negative (-) speaker terminals respectively on the amplifier. Neutrik [NL4FX] and [NL4FC] Speakon speaker cord can be used for the connection. Please refer to Neutrik for more information.

1. Switch off the power of your amplifier.
2. Connect the speaker cables to the speaker connector on the back of the speaker.
For input terminal polarity, red is positive (+) and black is negative (-).
3. Connect the other ends of the cables to the amplifier's speaker output terminals (for details, refer to your amplifier's instruction manual).
 - Connect the speaker cables to the amplifier's speaker output terminals:
Speakon 1+ → amplifier +
Speakon 1- → amplifier -

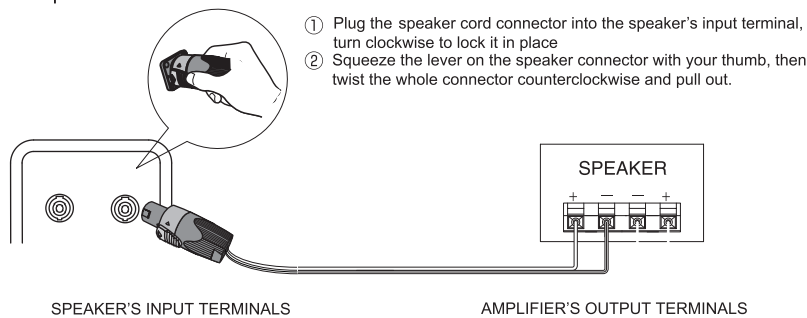

WIRING OF THE SPEAKER

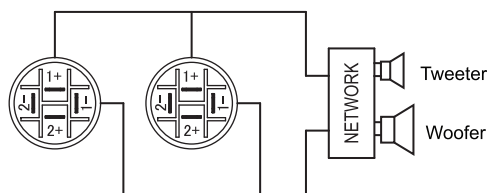

CONNECTING OTHER SPEAKER

- On the rear of the speaker are two terminals; you can use these to connect another speaker of the same type to this speaker.
- The number of speakers you may connect will vary according to the impedance rating of the amplifier. See the manual that came with your amplifier for more details.
- The diagram below shows the wiring of two connected speakers.

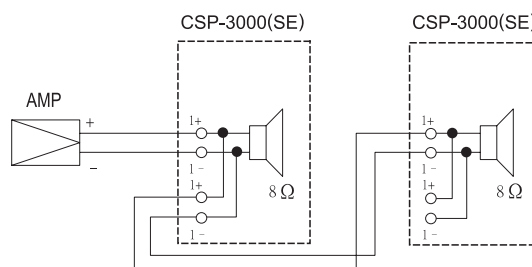

ROTATED THE BADGE

- The badge of the products can be rotated.
- Nameplates rotation when pulled out be careful not to use excessive force in order to avoid badge or iron mesh deformation.

MAINTENANCE OF CABINET

- When the cabinets are dirty, clean off the dirt with a soft cloth.
- If the dirt is engrained, moisten a soft cloth in cold or lukewarm water, wring it out, and then wipe off the dirt. Never use thinners or alcohol since these substances can impair the finish of the cabinet. Also, avoid using insecticide and other sprays near the speakers.

SPECIFICATIONS

Type Two-way loudspeaker, bass-reflex
 Speaker units 250 mm Cone Type Woofer With 60 mm Coil x1
 26 mm Throat, 34.4 mm Coil Diaphragm Assembly Type x 1
 Frequency response 75 Hz ~ 20,000 Hz (± 3 dB)
 Sensitivity 97 dB/W/m
 Max SPL Peak 128 dB/m
 Max SPL Continuous 124 dB/m
 Rate Power 300 W
 Max Power 1200 W
 Music Singal Power 600 W

Dispersion Coverage $H80^\circ \times V50^\circ$
 Connector Neutrik Speakon[®] NL4MP x 2
 Nominal Impedance 8 Ω
 Dimensions W315 x H527 x D293 mm
 N.W. 16.9 kg
 Enclosure Material 15 mm Plywood
 ACCESSORIES Owner's manual x1
 Registration card x1

APPEARANCE DRAWING

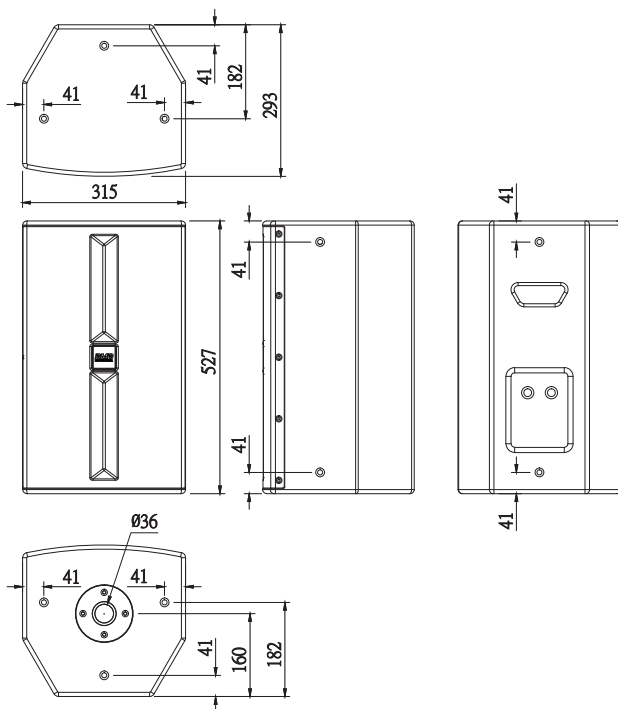

STANDARD FREQUENCY RESPONSE

SOUND PRESSURE LEVEL FREQUENCY RESPONSE

Position (straight ahead from the tweeter)

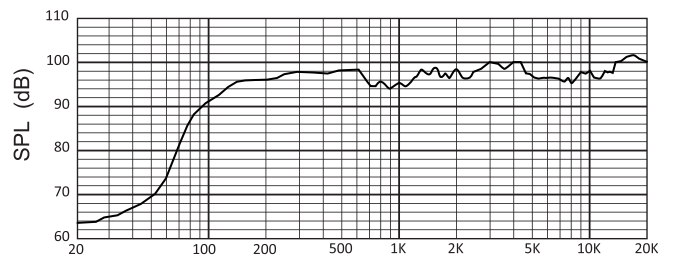

IMPEDANCE FREQUENCY RESPONSE

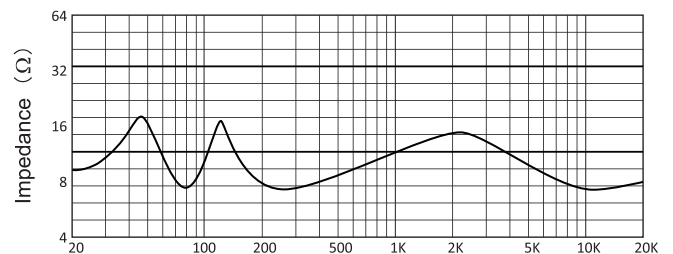

- The specifications and design of this product are subject to change without notice, in the interests of improvements.

BMB International Corp.
<http://www.bmb.com>